

8021, 8071 SERIES

Pneumatic Toggle Clamps | Product Overview

Features:

- Enclosed clamp for dirty environments such as spot and MIG welding
- Non-pivoting cylinder can be hard-piped into fixtures
- Sensor ready for round or T-slot style sensors

Applications:

- Assembly
- Welding

Also Available:

See page MC-ACC-1 for spindle accessories

See page MC-PSC-40 for sensing options

8021 ⓘ
8021-UE ⓘ



8071
8071-UE



Technical Information | Holding Capacities

Model	Maximum Holding Capacity		Max. Exerting Force @ 5bar [72PSI]		Weight	Bore Size	Air Consumption† dm ³ [ft ³]	Port Size	Accessories (Supplied)	
	Inner	Outer	Inner	Outer					Spindle Accessory	Flanged Washer
8021 ⓘ	[390 lbf]	[255 lbf]	[169 lbf]	[100 lbf]	[2.30lb]	[1.26]	[0.015]	1/8 NPT	--	8021122
8021-UE ⓘ	1735 N	1135 N	760 N	449 N	1,04kg	32	0,42	G-1/8		
8071	[450 lbf]	[310 lbf]	[496 lbf]	[283 lbf]	[2.80lb]	[1.57]	[0.020]	1/8 NPT	--	507107
8071-UE	2000 N	1380 N	2218 N	1267 N	1,27kg	40	0,58	G-1/8		

ⓘ This item is available upon request. †Per double stroke at 5bar [72PSI]

Max Cylinder Pressure: 10bar [145psig]*

Max Operating Temp: -10°C to 90°C [-14°F to 194°F]

Replacement Seal Kit: 8021: 802450-32-1-00
8071: 810450-40-1-00

*In no case should the inlet pressure be high enough to create an exerting force that exceeds the clamp's holding capacity. See Technical Appendix Section for details.

Sensor Accessories

	Item Number
Round Reed Switch with Quick Disconnect	810169
T-slot Reed Switch with Quick Disconnect	8EA-109-1
Quick Disconnect 2M Extension Cable	CABL-010
Quick Disconnect 5M Extension Cable	CABL-013

See Pneumatic Accessories section for more options

8021, 8071 SERIES

Pneumatic Toggle Clamps | Dimensions | -UE

8021
8021-UE

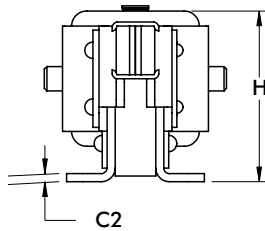

8071
8071-UE

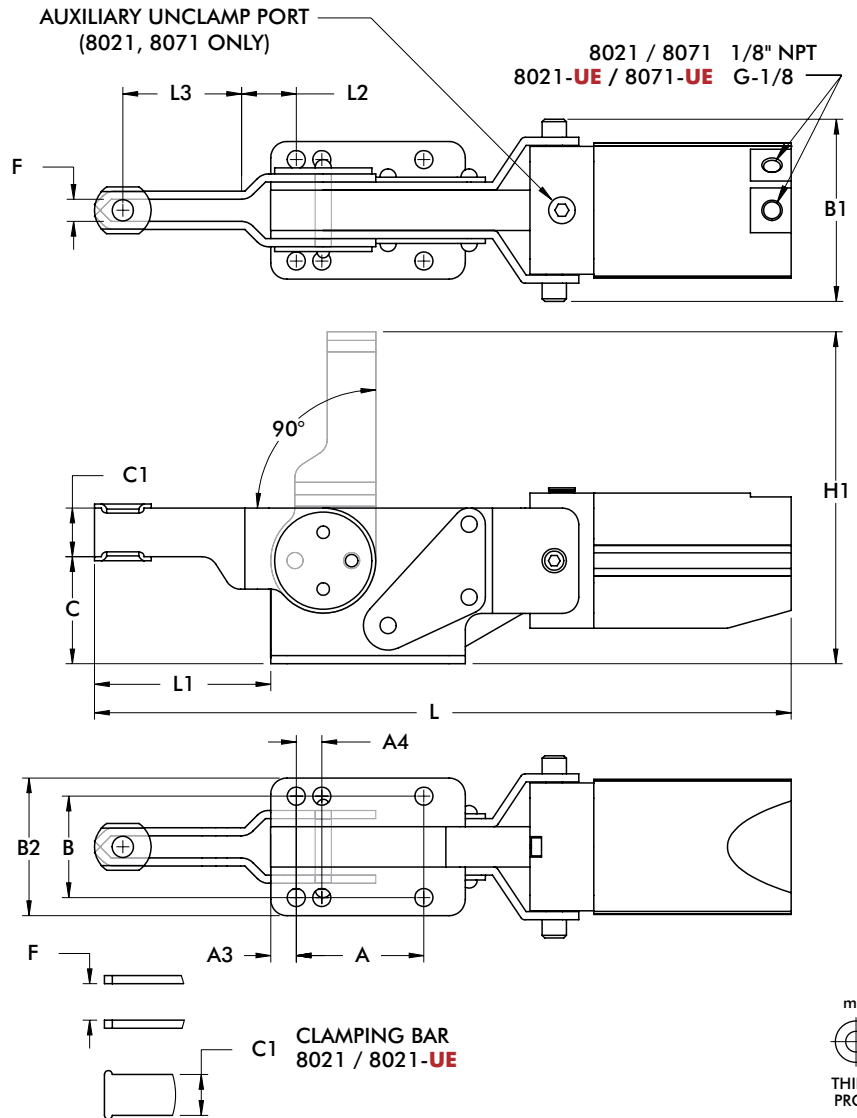

Model	A	A1	A3	A4	B	B1	B2	C	C1	C2	ØD	F
8021	[0.79]	[1.97]	[0.47]	-	[1.50]	[2.26]	[1.88]	[1.56]	[0.63]	[0.13]	[0.21]	[0.34]
8021-UE	20	50	12	-	38,2	57,4	47,9	39,6	16	3,2	5,3	8,7
8071	[1.97]	[3.00]	[0.39]	[0.39]	[1.56]	[2.81]	[2.12]	[1.65]	[0.75]	[0.13]	[0.28]	[0.56]
8071-UE	50	76,2	10	10	39,7	71,4	53,9	41,9	19,1	3,2	7,1	14,3

Model	H	H1	L	L1	L2	L3	M
8021	[2.40]	[4.44]	[9.86]	[2.25]	[0.44]	[1.31]	1/4
8021-UE	60,9	112,8	250,4	57,2	11	33,2	M6
8071	[2.63]	[5.12]	[10.74]	[2.72]	[0.40]	[1.83]	5/16
8071-UE	66,9	130	272,9	69	10,1	46,5	M8